

Digital version:
Kann mit oder ohne Anzeigeeinheit verwendet werden.
Can be used with or without display unit.

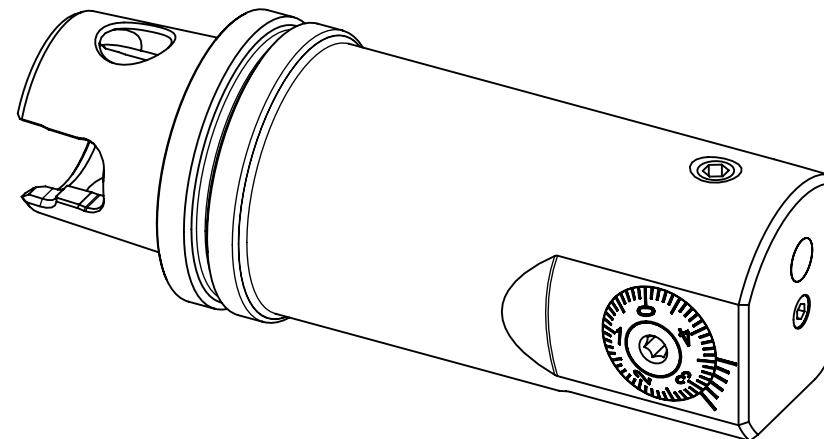
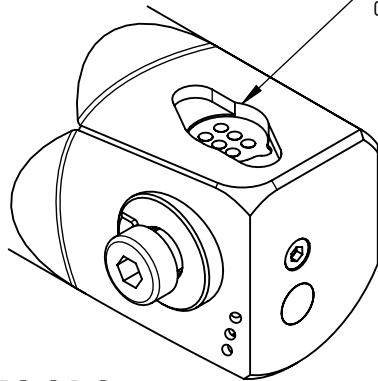

SWISSETOOLS

Feinbohrkopf digital_Fine boring head digital
KM4.F32.040.090-D

KM Ø40 / F32
Gewicht: 688g

Datum: 21.07.2020