

Digital version:  
 Kann mit oder ohne Anzeigeeinheit verwendet werden.  
 Can be used with or without display unit.

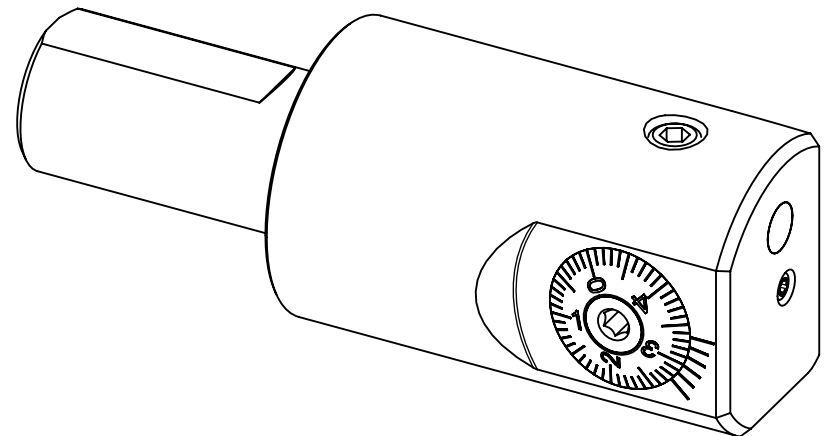

## SWISSETOOLS

Feinbohrkopf digital\_Fine boring head digital  
 W31.F55.067.100-D

Ø1 1/4" / F55  
 Gewicht: 2057g

Datum: 05.08.2020